



TORNOS

*We are your partner  
at the frontier of  
medtech innovation.*

MEDICAL & DENTAL

## Ageing population

Projected global population aged 60 years or over

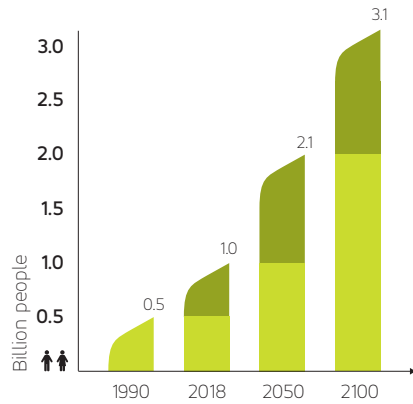

## World population

Projected world population until 2100

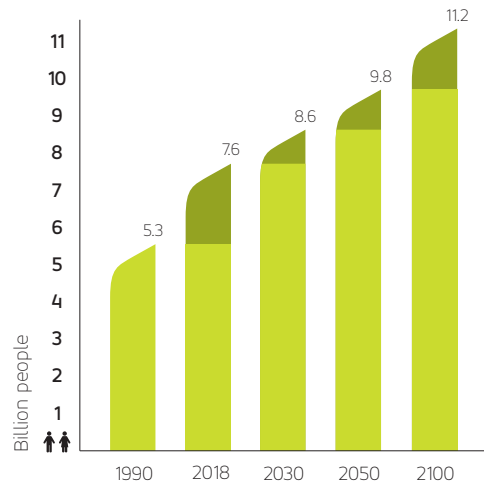

## Global life expectancy

Projected global life expectancy at birth\*

\* Life expectancy data from the World Population Prospects are average values referring to five-year periods.

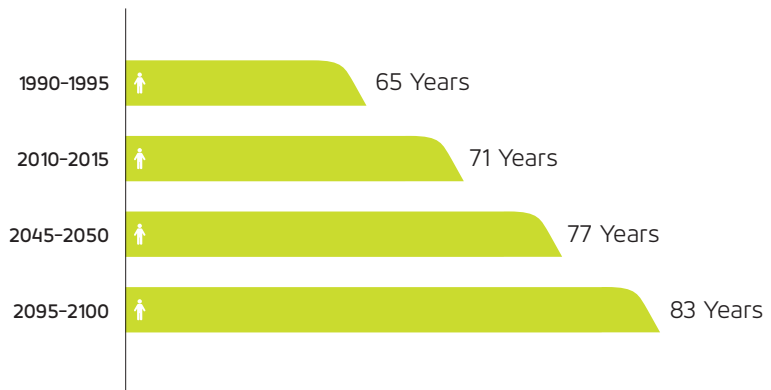

## Global medical device sales

Forecast to 2030

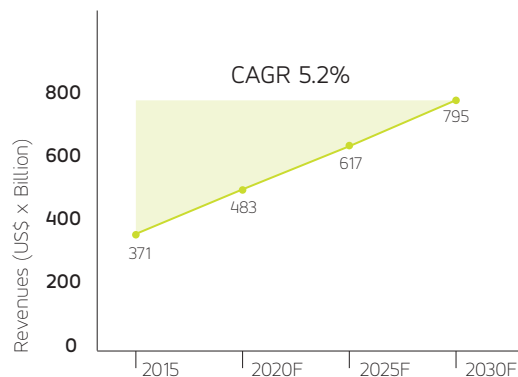

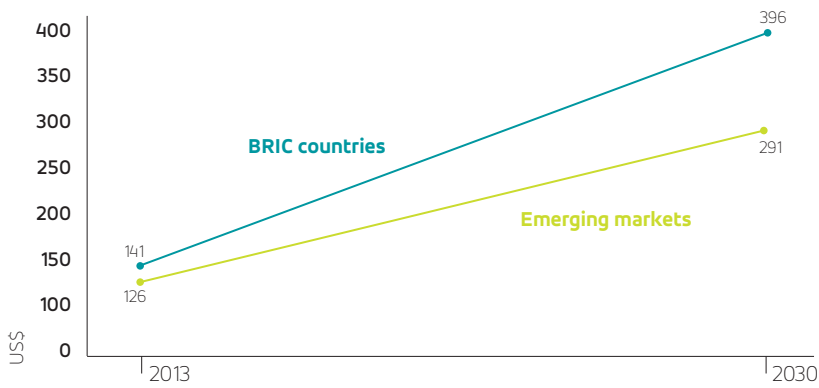

**Medtech industry consumer expenditure**  
BRIC countries versus emerging markets

## Medical devices technology

Roadmap to 2030

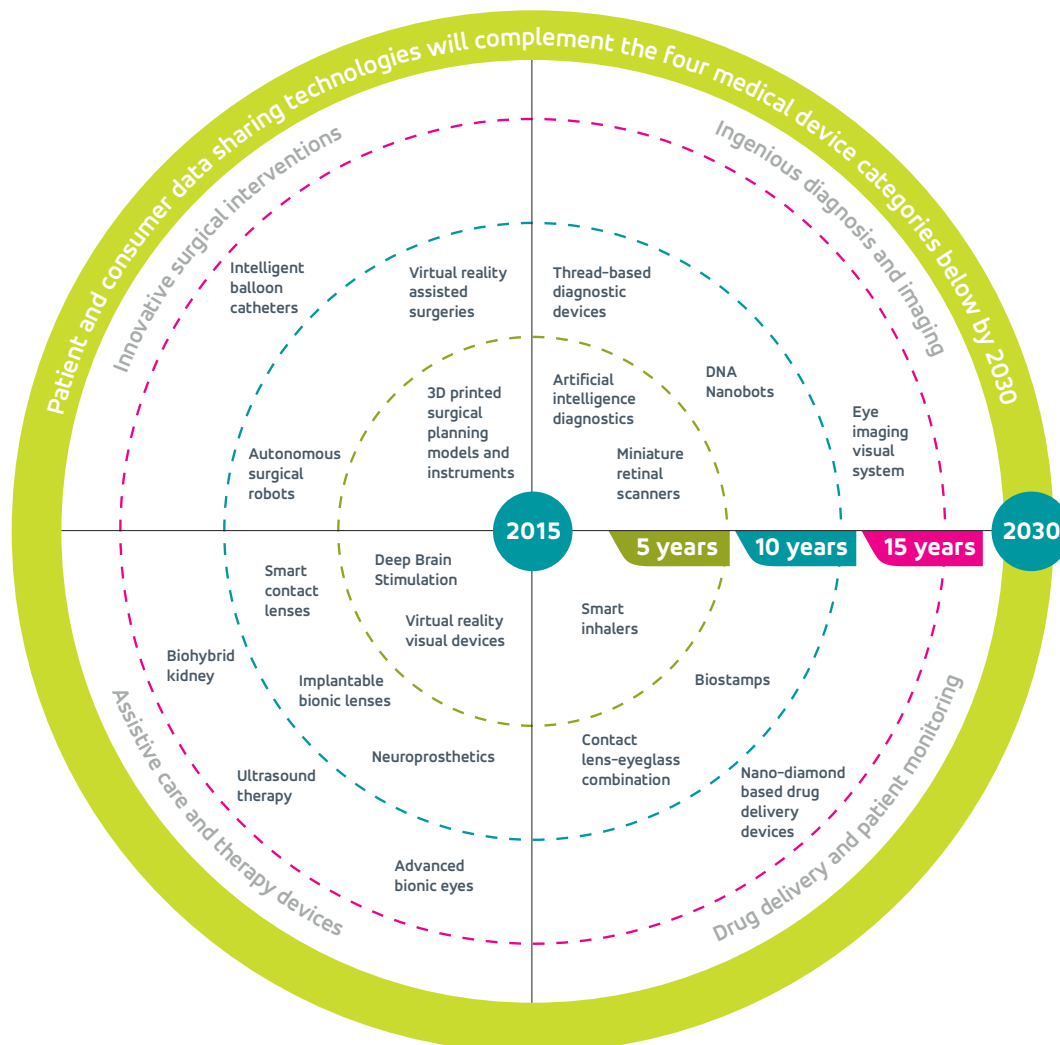

Source: Medical devices 2030, KPMG (2018)

# A changing health care landscape

MEDTECH CHALLENGES AND OPPORTUNITIES ARE DRIVEN BY DEMOGRAPHIC DYNAMICS, GLOBALIZATION, AND GLOBAL TECHNOLOGY DIFFUSION

From changing demographics and globalization to the accelerating pace of technology diffusion and innovation, macroeconomic forces are creating opportunities—and pressures—for manufacturers of medical devices and instruments. These key megatrends—global, sustained and macroeconomic forces of development that impact business, economy, cultures and personal lives—are shaking up the status quo, giving rise to new business challenges and a more demanding regulatory landscape, and setting the stage for medtech industry growth. The world's population is increasing and it is aging, while urbanization presents new health risks; globalization has led to an increased gross domestic income and health care spending in developing countries; and technology and innovation are leading to new health care devices and manufacturing solutions.

Medical devices are used in the prevention, diagnosis or treatment of illness or disease, or for detecting, measuring, restoring, correcting or modifying the structure or function of the body for some health purpose. These devices range from the simple to the sophisticated—and there are more than 5,000 to 24,000 different types of medical devices available today.<sup>1</sup> Medical equipment, on the other hand, is used for specific purposes of diagnosis and treatment of disease or rehabilitation following disease or injury, and includes medical devices requiring calibration, maintenance, repair, user training and decommissioning, but excludes implantable, disposable or single-use medical devices.<sup>2</sup> Global spending on health in 2021 was US \$9.8 trillion<sup>3</sup>—or 10.3

percent of global gross domestic product (GDP)<sup>3</sup>. Furthermore, World Health Organization (WHO) Sustainable Development Goals (SDGs) establish targets that will require a substantial increase in focus on and investment in health. For example, noncommunicable diseases (NCDs) today account for nearly 75 percent of all deaths globally; if this trend continues, that number could reach 86 percent by 2048.<sup>4</sup> **Global medical device sales—representing only a slice of worldwide health spending—are forecast to grow by more than 5 percent per year to US \$800 billion by 2030.**<sup>5</sup>

## Changing demographics

In the next 30 years, world population is expected to increase from the current 8 billion to 9 billion. Driving this dramatic growth are the increasing numbers of people living to reproductive age, increasing lifespan, urbanization, and migration, accompanied by major changes in fertility rates. These trends bring with them **significant implications on several fronts, including health care.**<sup>6</sup>

At the same time, **the world's population is aging:** The 60-plus population is growing faster than all younger age groups, and the number of people 60 and older is expected to double by 2050 and more than triple by 2100. The United Nations predicts that **population aging will drive significant social transformation**, impacting every corner of society from labor and financial markets to the demand for goods and services.<sup>7</sup> **The global aging trend spells increased opportunities for compa-**

1 World Health Organization, Health products policy and standards, Nomenclature of medical devices, <https://www.who.int/teams/health-product-policy-and-standards/assistive-and-medical-technology/medical-devices/nomenclature>

2 World Health Organization, Health products policy and standards, Medical devices, Definitions, <https://www.who.int/teams/health-product-policy-and-standards/assistive-and-medical-technology/medical-devices>

3 WHO, Global spending on health: Coping with the pandemic, 2023, p. 2

4 WHO, World Health Statistics 2023: Monitoring health for the SDGs, 2023, p. 10

5 KPMG, Medical devices 2030: Making a power play to avoid the commodity trap, 2018, p. 3

6 United Nations, Global issues, World population, <https://www.un.org/en/global-issues/population>

7 United Nations, Global Issues, "Ageing," <http://www.un.org/en/sections/issues-depth/ageing/>

8 UBS, *Longer Term Investment*, April 2023, p. 1

9 UBS, *Longer Term Investment*, April 2019, p. 2

# 34,000 medtech companies in Europe

**nies selling medical products and devices**, since people 65 and older account for the majority of medical device use.<sup>8</sup> Case in point: two-thirds of hip implant patients are over 65.<sup>9</sup> The **global orthopedics and sports medicine market**, which includes replacement joints, spinal fusion, bone repair plates and sports medicine surgical equipment, **is estimated at US \$45.5 billion**, and the consumer medical devices market is valued at US \$31.4 billion while the dental implant market is valued at US \$4 billion. The market for cardiovascular devices such as pacemakers, implantable cardioverter-defibrillators, stents and heart valve treatment products is valued at US \$37.9 billion.<sup>10</sup>

**Urbanization is another factor contributing to medical device demand.** Today, for the first time in history, more than 55 percent of the global population lives in urban areas. That figure is set to rise to 68 percent by 2050.<sup>11</sup> That staggering increase in urbanization potentially could provide better access to health care, but it will bring challenges, too, since **modern urban environments can concentrate health risks and pose new hazards.** For example, urban environments provide inhabitants with greater access to high-calorie food, have more passive transportation and less outdoor recreational space, greater exposure to mass media food and beverage marketing, and less-work related activity.<sup>12</sup>

Obesity is linked to the urbanization trend; it puts additional pressure on the knee joints and increases the risk of damaged cartilage and the need for orthopedic surgery.<sup>13</sup> In fact, **obese patients are** at significantly greater risk for osteoarthritis and, as a result, **8.5 times more likely to require knee replacement surgery** than patients with a normal body mass index.<sup>14</sup>

## Globalization

Defined as the development of an **increasingly integrated global economy**, globalization has the potential for both positive and negative effects on global development and health. Globalization and growth of future markets are expected to remain key drivers of the global economy, with worldwide exports growing faster than worldwide gross domestic product (GDP): Worldwide exports are forecast to triple by 2030, and emerging and developing economies' exports are set to grow fourfold. BRIC countries Brazil, Russia, India and China are poised for exceptional economic growth, with their real GDP doubling by 2030. GDP growth in BRIC and emerging economies will impact health care, too: By 2030, BRIC countries' per capita health care spending is expected to more than double compared to 2013 expenditures; per capita health care expenditures in emerging economies will also more than double.<sup>15</sup>

Fast-growing GDP and expansion of the middle class are also expected in other country clusters, including the Next 11 (Bangladesh, Egypt, Indonesia, Iran, Mexico, Nigeria, Pakistan, Philippines, Turkey, South Korea and Vietnam), MINT (Mexico,

<sup>10</sup> Ibid, p. 5

<sup>11</sup> World Health Organization, Urban health, [https://www.who.int/health-topics/urban-health#tab=tab\\_1](https://www.who.int/health-topics/urban-health#tab=tab_1)

<sup>12</sup> Harvard University T.H. Chan School of Public Health, Urbanization and Obesity, <https://www.hsph.harvard.edu/obesity-prevention-source/obesity-and-urbanization/>

<sup>13</sup> UBS, *Longer Term Investment*, April 7, 2017, p. 7

<sup>14</sup> American Academy of Orthopaedic Surgeons, *Position Statement: The Impact of Obesity on Bone and Joint Health*, p. 2

<sup>15</sup> Roland Berger, *Trend Compendium*, "Globalization & future markets," p. 14

Indonesia, Nigeria and Turkey) and MIST (Mexico, Indonesia, South Korea and Turkey).<sup>16</sup>

Health care has remained largely regional and local, but **health care systems are feeling the financial pressure of globalization: Competing in a global marketplace is impacting their revenue bases and spending patterns.** Globalization—a historic driver of change—also lays the foundations for health care without borders, giving rise to new social and political models.<sup>17</sup>

Adding another layer of complexity for medical device manufacturers competing in the global marketplace are demanding—and changing—medical device regulations. Relatively unchanged since the 1990s, **Europe's medical device regulations have undergone sweeping change** in order to harmonize and simplify them and improve transparency and product traceability.<sup>18</sup> The New European Union Medical Device Regulations (EU MDR) announced in mid-2017 are significantly transforming how medtech companies develop and market their products in Europe. The EU MDR sets new standards for product safety and function: Medical device companies registering devices in Europe must measure clinical performance and continue to collect clinical data after market launch.<sup>19</sup> Cost of compliance is a concern: **Europe is the world's second-largest medtech market, valued €160 billion and encompassing 34,000 medtech companies,** 95 percent of which are small and medium-sized companies. Moreover, industry sources say it accounts for more than 800,000 jobs in Europe and registers more patents than any other sector.<sup>20</sup>

### Technology and innovation

Innovation is the fruit of technology and it is laying the foundation for health care for a growing and aging population. From medical dosing devices to biocompatible implants, **medical device innovation is improving patients' long-term health outcomes and quality of life.** Innovation is driving wealth, and technology

diffusion is making consumers more active participants in their own health care. That innovation drives wealth is no secret, as indicated by patent applications per capita and prosperity, indicating that **innovation a more sustainable path to wealth than exploitation of natural resources.**<sup>21</sup> At the same time, technology is being diffused globally at a faster pace than ever before and it isn't confined to developed economies. Forecasters expected **43 billion connected "things" to be in use worldwide in 2023,**<sup>22</sup> with the global Internet of Things (IoT) market expected to grow from US \$662.21 billion in 2023 to \$3,352.97 billion by 2030, at a compound annual growth rate of 26.1 percent.<sup>23</sup> **Technology also plays a role in disrupting the traditional model of medicine in favor of patient consumerism,** with patients taking increasing ownership in their health care by "shopping by phone" or online for health care services or perusing online resources prior to visiting a doctor.<sup>24</sup> This can put health care organizations under greater pressure to increase access to consumer-friendly services while decreasing costs.<sup>25</sup> **The convergence of technology, innovation and health care consumerism sets the stage for precision medicine**—also known as personalized medicine—in which relevant data is used to define individual patterns of disease, potentially leading to better individual treatment.<sup>26</sup>

Technology and innovation—digitalization, in particular—are providing ways for medical device manufacturers to confront the challenges of the increasing device complexity and a changing medical device regulatory environment. Industry 4.0—a manufacturing future supported by cyber-physical systems—has the potential to advance medical device manufacturers compliance with regulations, traceability, time to market, and global supply chain visibility.

800,000+  
jobs in Europe

16 Ibid, p. 15

17 IBM Global Business Services, IBM Institute for Business Value, *Healthcare 2015: Win-win or lose-lose?*, p. 4

18 Deloitte, *Preparing for the future: The new European medical devices regulation*, p. 3

19 Ernst & Young, *Pulse of the Industry 2017: As change accelerates, how can medtechs move ahead and stay there?*, p. 28–29

20 MedTech Europe, *The European Medical Technology industry in figures, 2022*, p. 12, 17, 21, 26

21 Roland Berger, *Trend Compendium*, "Dynamic technology & innovation," p. 9

22 Forbes, "The Top 4 Internet Of Things Trends In 2023," November 7, 2022,

<https://www.forbes.com/sites/bernardmarr/2022/11/07/the-top-4-internet-of-things-trends-in-2023/?sh=430effe92aea>

23 Fortune Business Insights, *Internet of Things Market Size, Share & Growth by 2030*, April 2023,

<https://www.fortunebusinessinsights.com/industry-reports/internet-of-things-iot-market-100307>

24 World Economic Forum, "Seven global medical technology trends to look out for in 2017," December 22, 2016,

<https://www.weforum.org/agenda/2016/12/seven-global-medical-technology-trends-to-look-out-for-in-2017/>

25 PwC, *Medical Cost Trend: Behind The Numbers 2017*, June 2017, p. 4

26 US Food & Drug Administration, *Paving the Way for Personalized Medicine: FDA's Role in a New Era of Medical Product Development*, p. 6

# We keep you turning

*Few industries are as regulated—or as associated with the need for quality, safety and transparency—as the global medical device manufacturing sector. And no partner is more committed to advancing medical device and instrument manufacturers' precision, quality and return on investment as Tornos. For more than 30 years, Tornos has closely collaborated with medical device manufacturers worldwide to help them deliver impeccable products that improve patients' quality of life.*

*With our vast experience throughout the med-tech production chain, our holistic approach, our complete production program and our global presence, we are the perfect partner to medical device and instrument manufacturers and their suppliers.*

*Moreover, thanks to our experience across a broad range of industry segments, Tornos is uniquely positioned to partner with manufacturers, offering them support to deal with increasing product complexity, for example.*

*Tornos offers you professional, specialist solutions in this very demanding field. To meet the needs of the medtech industry, major technical advances are required. Relying on our technology, our quality and our experience in medical and dental manufacturing is the key to success.*

*We invite you to discover our solutions by contacting us or by simply visiting our website.*

*Ever increasing demands for uncompromising precision and quality at the best price put great pressure on supply chain partners. Tornos guarantees the latest technology in terms of precision and performance to meet those requirements.*



# Legacy materials and emerging materials

SAFETY AND QUALITY LEAD THE LIST OF PRIORITIES WHEN IT COMES TO BIOMATERIALS FOR MEDICAL AND DENTAL DEVICES. WHETHER THE DEVICE IS MADE OF A CONVENTIONAL OR EMERGING MATERIAL, THERE IS NO ROOM FOR RISK.

*In the world of medical and dental device manufacturing, where the end product directly impacts patient health, there is little room for risk. That's why regulatory bodies so carefully assess the biocompatibility—the ability of a device material to perform with an appropriate host response in a specific situation<sup>27</sup>—of new materials proposed for use in human body.*

*Naturally, to ensure safety and quality, biocompatibility and risk management are top priorities when medical device manufacturers' engineers consider new materials for their products in development. Pressing concerns when considering new materials range from the material's physical properties and whether it will meet requirements for its use to how the material will be processed, chemical and biological properties, and regulatory requirements. Another consideration is material cost, and its importance can vary, depending on the type of device to be produced. For example, cost considerations would be more important for high-volume, single-use end products than the cost of materials for reusable or implantable devices<sup>28</sup>.*

*Legacy biomaterials such as titanium, magnesium, stainless steel, platinum and newer biomaterials including chrome-cobalt and polyether ether ketone (PEEK) are all within the purview of Tornos' solutions. Moreover, as Tornos keeps a keen eye on the materials science landscape, it continuously adapts its solutions to master new hybrid biomaterials and those materials in renaissance, including magnesium for its biodegradable properties.*

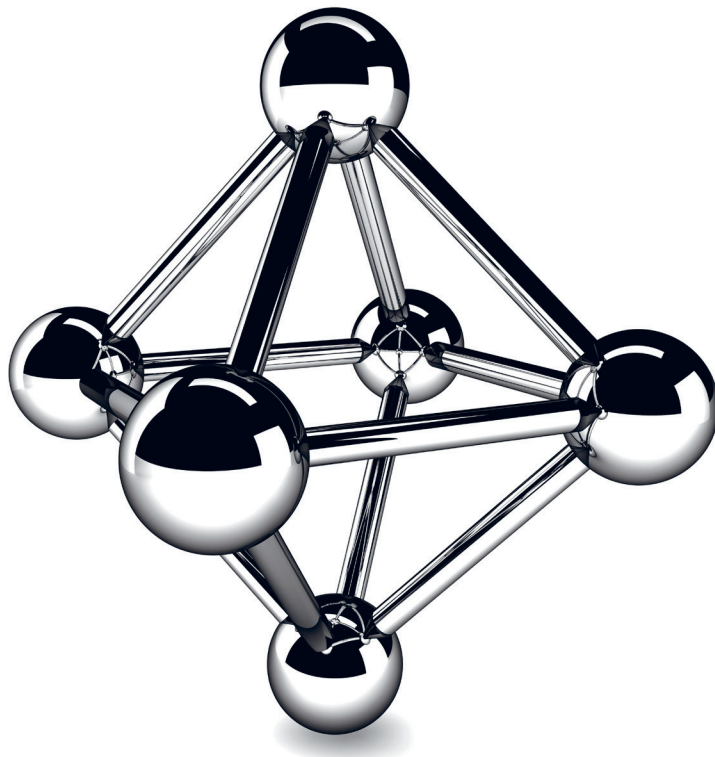



*To ensure that you meet your industry's quality standards, Tornos collaborates with leading tooling manufacturers to develop advanced machining strategies for your medtech applications. This deep know-how positions Tornos to best support you in turning a wide range of implants—however complex—including bone screws and dental implants. From corrosion- and wear-resistant titanium to stainless steel and special alloys capable of withstanding the human body's demands, your partners at Tornos help you masterfully machine even challenging materials.*

*So, whether you are pioneering a breakthrough device from a conventional or new biomaterial or looking to fine-tune the manufacturing process around an existing device, Tornos is your expert partner when it comes to precision, productivity and profitable machining.*

- 27 United States Food and Drug Administration, *Use of International Standard ISO 10993-1, "Biological evaluation of medical devices - Part 1: Evaluation and testing within a risk management process," Guidance for Industry and Food and Drug Administration Staff*, p. 66, 2016
- 28 MED DEVICE ONLINE, "An Introduction To Emerging Polymers For Medical Devices," September 28, 2015, <https://www.meddeviceonline.com/doc/an-introduction-to-emerging-polymers-for-medical-devices-0001>



# Powering your perfect production

SPINAL INSTRUMENTATION USES TITANIUM, TITANIUM ALLOYS, STAINLESS STEEL OR NON-METALLIC DEVICES IMPLANTED INTO THE PATIENT'S SPINE TO PROVIDE LONG-LASTING SOLUTIONS TO SPINAL INSTABILITY. FROM POLYAXIAL AND MONOAXIAL SCREWS—including screw heads—to LOCKING NUTS AND INTERVERTEBRAL CAGES, TORNOS POWERS YOUR PERFECTION PRODUCTION OF SPINAL INSTRUMENTATION.

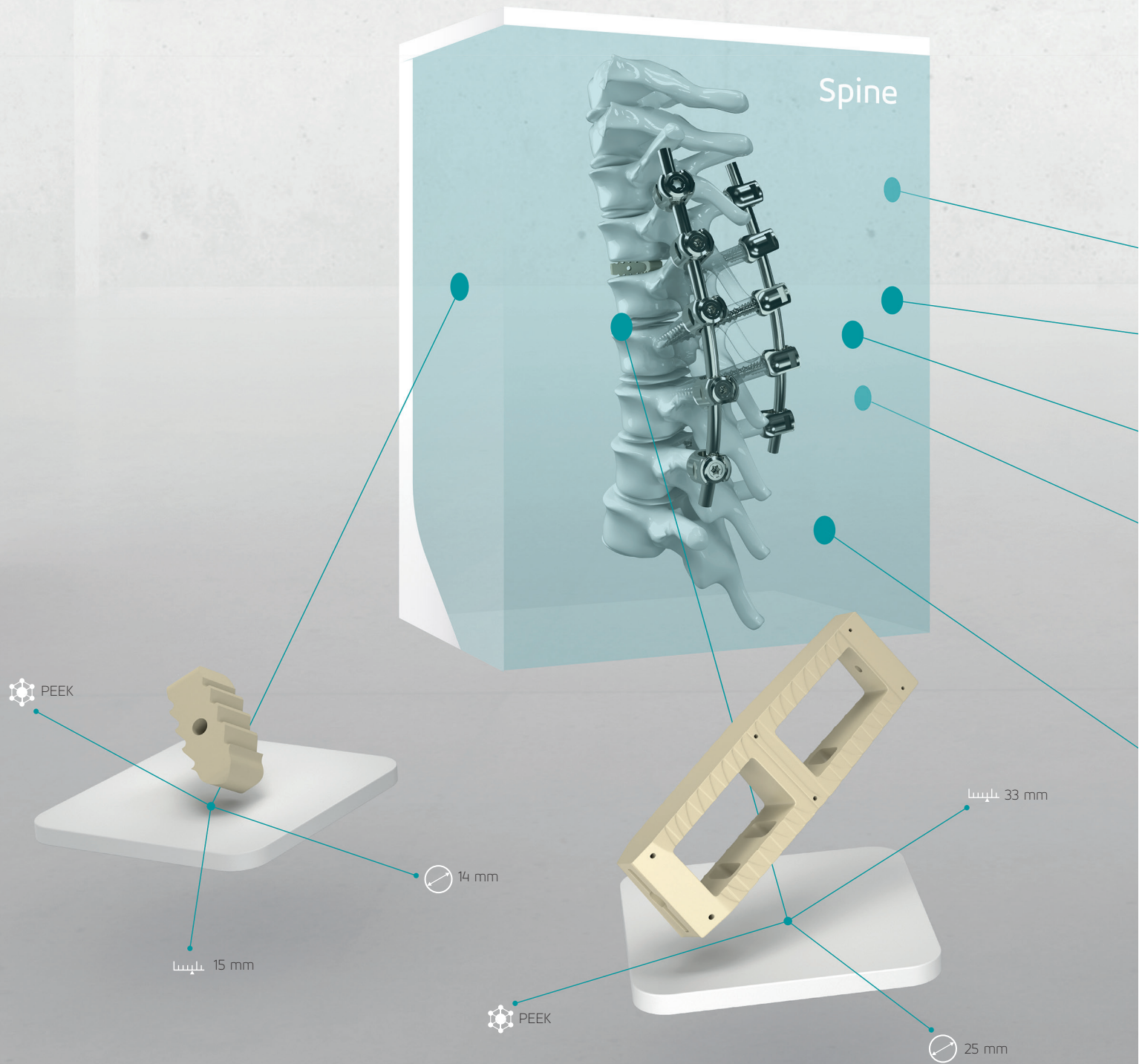

Material

Diameter (in mm)

Length (in mm)

### Polyaxial/monoaxial screw

Polyaxial and monoaxial screws have long been part of Tornos' repertoire of expertise. High-volume production of batches of tulip heads for these screws are perfectly produced with our solutions, including our multispindle machines, and this expertise extends to locking screws that fit the into the tulip head. Today, Tornos is unique in its ability to offer solutions for producing all three of these parts—polyaxial and monoaxial screws as well as corresponding locking nuts—with Swiss-type and multispindle technologies.

### Intervertebral cage

An intervertebral cage, often made of titanium or, today, PEEK, is used to treat certain neck and back conditions such as degenerative disc disease. Naturally, intervertebral cages can be produced with Tornos Swiss-type

machines, replacing traditional cutting fluid with air as needed. With a capacity of up to 36 mm, Tornos solutions can boost productivity on such parts and—notably—the tantalum location pin can be inserted into the cage with a loading device to eliminate secondary operations.

### Hook

Tornos also masters production of spinal instrumentation hooks, which can be used alone or to secure rods or cables in place in spinal surgery.

Furthermore, if your production requires vegetable-based lubrication to ensure biocompatibility, Tornos can factor that need in during assembly of your Tornos machine. From thread whirling, stamping and Torx® milling to high-frequency milling and deep drilling, Tornos has your spinal instrumentation manufacturing needs covered.

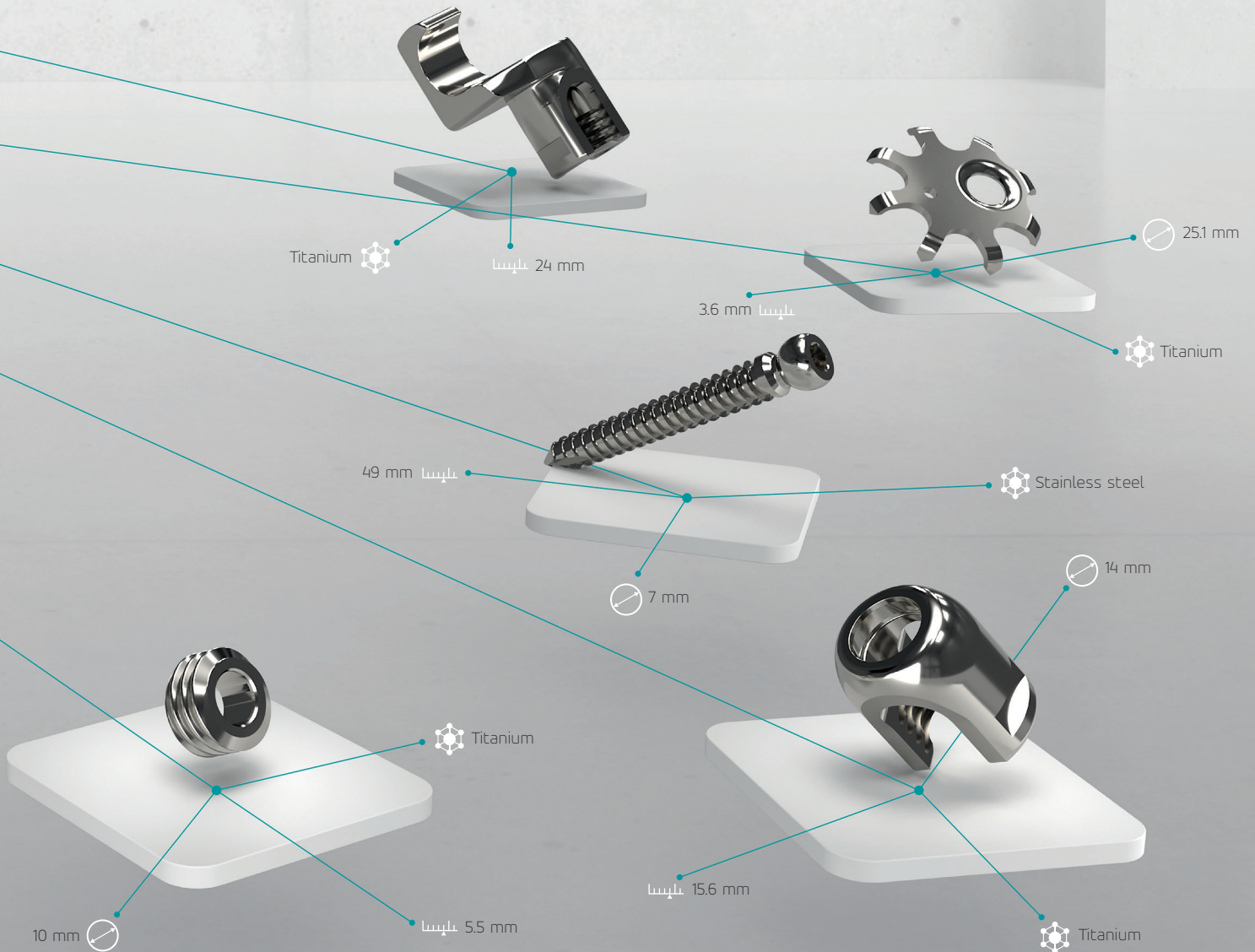

# Surgical precision redefined

THE MINIATURIZATION TREND REQUIRES HIGHLY PRECISE, SHARPLY THREADED SCREWS WITH HEADS ACCOMMODATING HIGH FORCES AND FLAWLESS LOCKING TO THE RECONSTRUCTIVE PLATE. AT THE SAME TIME, MINIATURIZATION OF MAXILLOFACIAL SCREWS AND PLATES DRIVES THE NEED TO MACHINE INCREASINGLY SMALL BARS OF MATERIAL. AS A PIONEER OF HIGH-PRECISION LATHES, TORNOS EXPERTLY ANSWERS THESE NEEDS.

*Maxillofacial surgery is the surgical specialty concerned with the diagnosis and treatment of conditions affecting the maxilla—the human upper jaw in which the bony elements are closely fused—and face. In terms of instrumentation, maxillofacial surgery often requires implantation of small, sharply threaded screws. These screws, available in a wide variety of shapes and increasingly small sizes, are made primarily of steel, titanium or chrome cobalt, each of which demands a different machining strategy.*

## Screws and plates

*Medical and dental device manufacturers today must produce ever-smaller screws aligned to the individual patient's requirements. Tornos—a pioneer of high-precision lathes—is uniquely positioned to offer the technologies essential to*

*keeping pace with this miniaturization trend, even in high volumes. Typically designed as taper screws with very sharp threads, screws for maxillofacial applications have heads that must accommodate high forces and should lock perfectly to the reconstructive plate.*

*Miniaturization also entails the ability to guide and machine very small—2–3 mm—bars of material. That's why Tornos spindles and guide bushes are perfectly aligned and manufactured to very tight tolerances. An investment in a Tornos solution brings the assurance that you will be able to guide your bar to the maximum spindle speed and exploit the full potential of your machine. Your results: better cutting quality and greater productivity.*

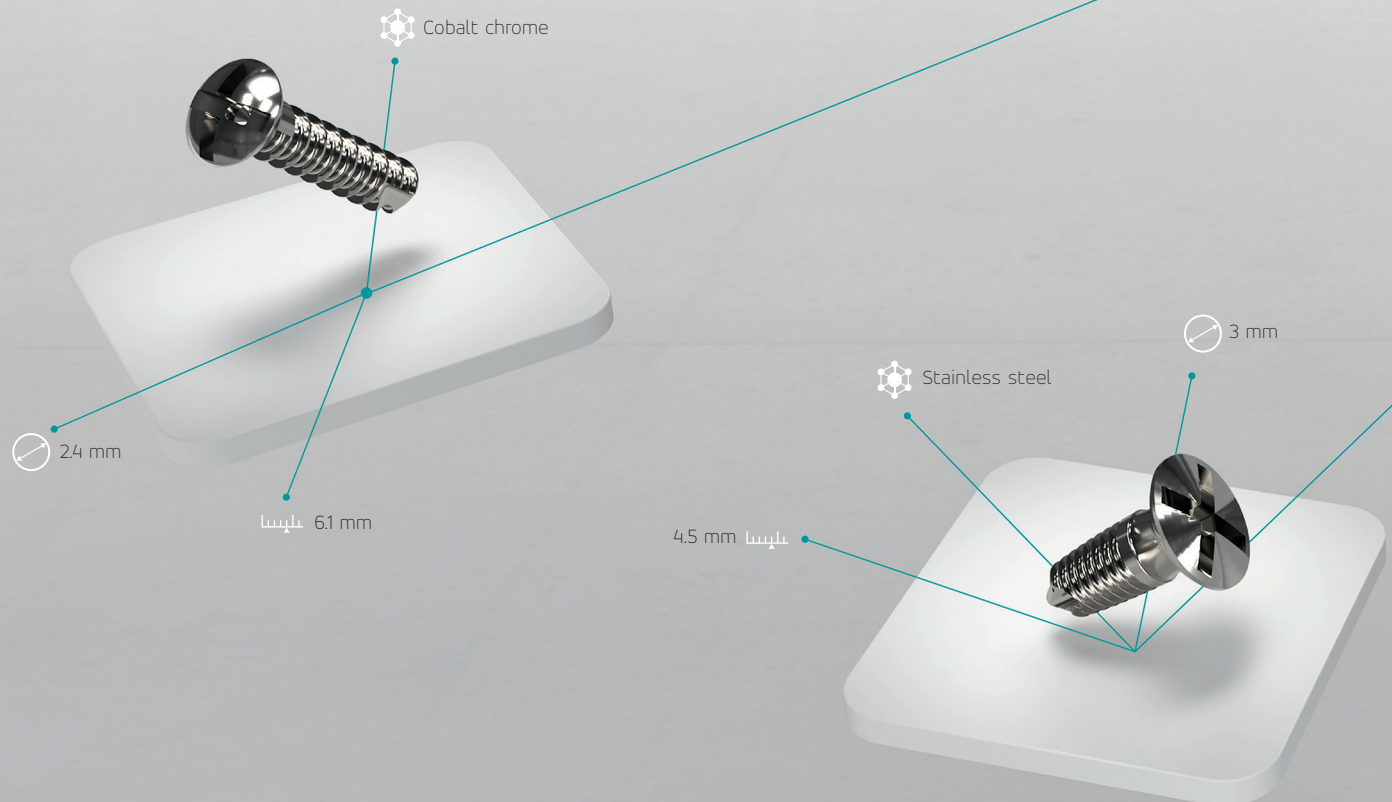

Material

Diameter (in mm)

Length (in mm)

# Maxillofacial



# The new benchmark for fixation

ORTHOPEDIC TRAUMA, SPECIALIZING IN PROBLEMS RELATED TO THE BONES, JOINTS AND SOFT TISSUES, SURGICAL TREATMENT OFTEN EMPLOYS BONE SCREWS AND OTHER DEVICES—PARTICULARLY PLATES—TO ENSURE FIXATION. AS A LONGTIME PARTNER OF ORTHOPEDIC IMPLANT MANUFACTURERS, TORNOS HAS VAST KNOWLEDGE IN THE PRODUCTION OF CANCELLOUS, CANNULATED AND CORTICAL BONE SCREWS, AS WELL AS LOCKING SCREWS.



Stainless steel (316)

15.8 mm

360 mm

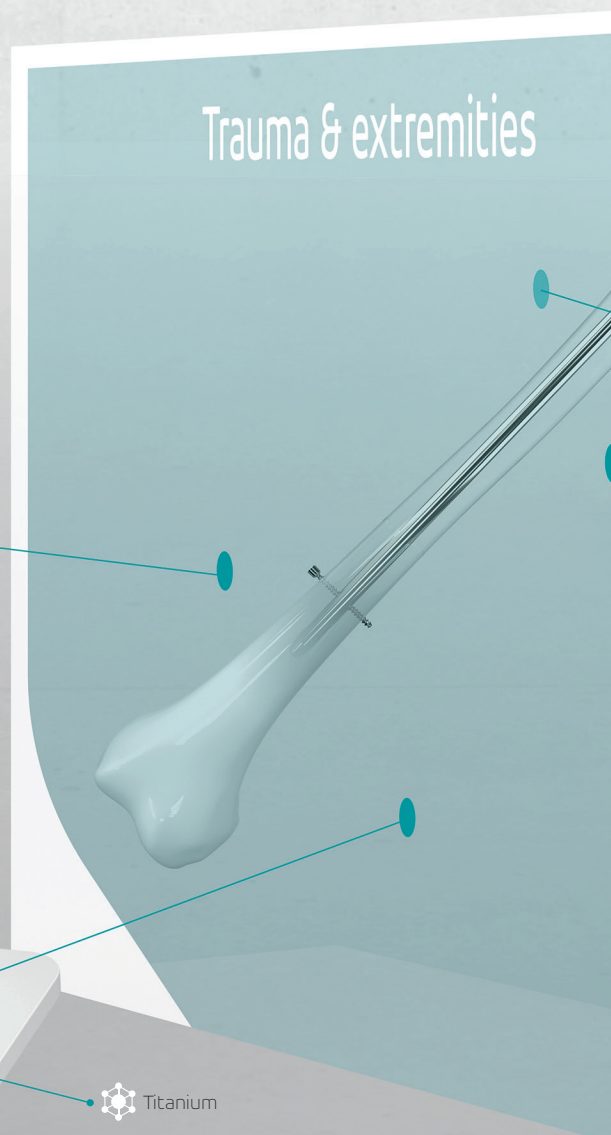

Trauma & extremities

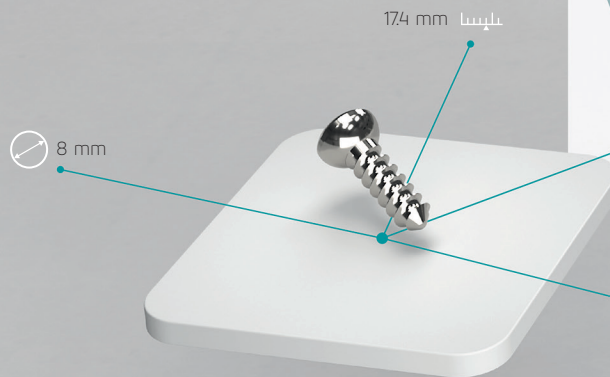

174 mm

8 mm

Titanium

Material

Diameter (in mm)

Length (in mm)

With diameters ranging from 1.5 to 16, these screws are made primarily of stainless steel or titanium, and machined in small to mid-sized batches. Cannulation—the machining of a hollow central shaft—for cannulated bone screws and machining of the sharpest of threads are Tornos specialties. In fact, Tornos was the first to master the thread whirling process on a sliding headstock lathe, more than 30 years ago, making it possible to produce screws with perfect threads, good surface finish and high dimensional accuracy. Tornos' thread whirling process significantly increases productivity, eliminates bending and vibration, and resolves the challenges of—for example—producing self-locking screws.

Furthermore, Tornos masters deep hole drilling with a vast array of solutions, from simple high-pressure pumps to high-end cutting fluid management to ensure burr-free and perfectly straight end products often as long as 360 mm.

Hip screws are another example of Tornos' orthopedics expertise, as they require greater machining power, particularly for machining the thread. That's where Tornos' high-end solutions clearly outpace standard machines. From nails and screws to plates, Tornos technologies position makers of orthopedic trauma and extremities products to stay highly productive and precise.

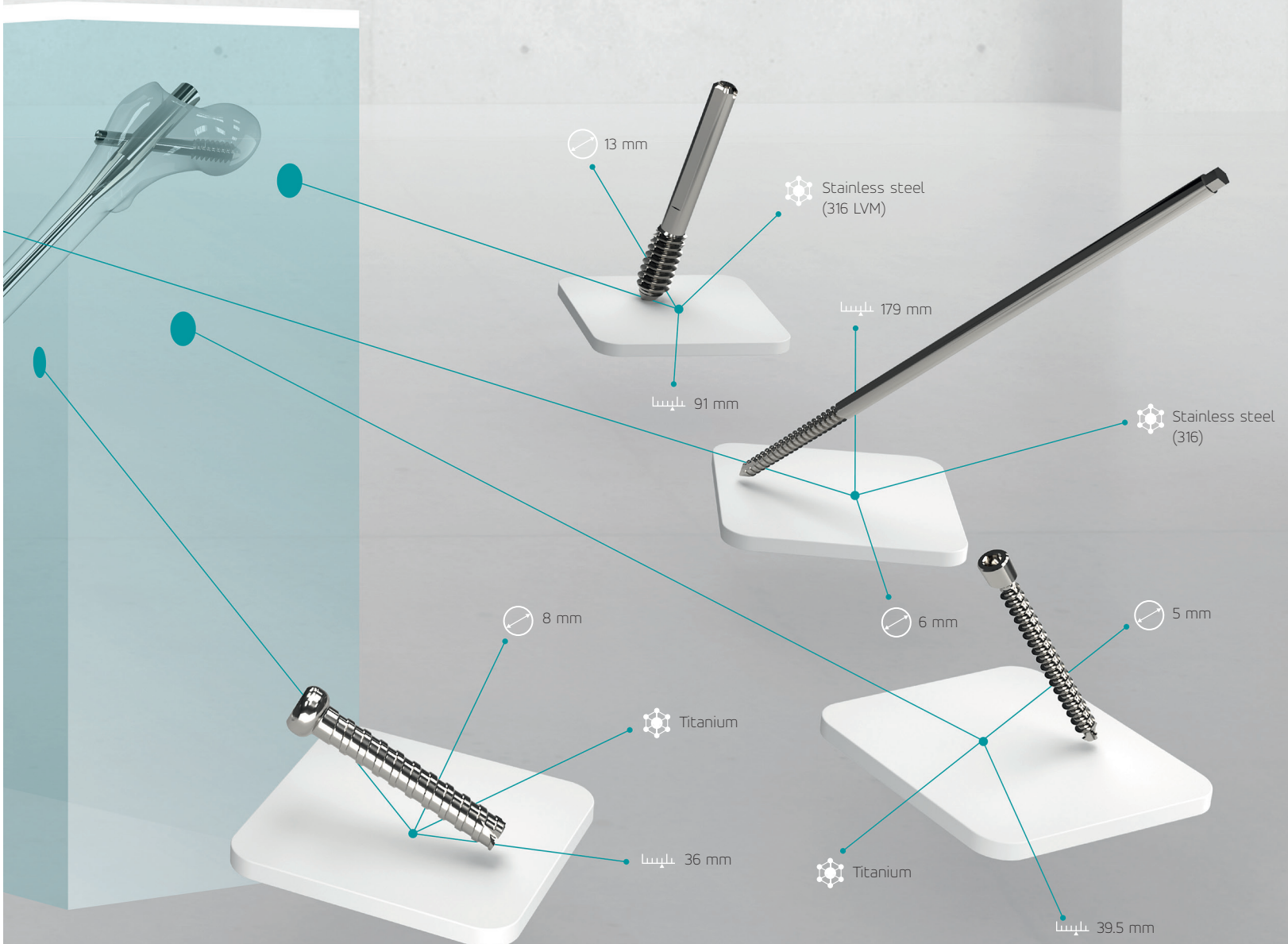

# We meet our customers' challenges with a legacy of medical expertise.

## Your challenges

*In the highly competitive medical and dental device manufacturing market, outpacing and outperforming competitors depends on a variety of factors. You're a precision machining specialist and you depend on the latest know-how to overcome your challenges. These include:*

- *Getting your foot in the door in the first place by conquering the demanding production*
- *Keeping your costs in check while increasing productivity*
- *Gaining the fast setup essential to producing increasingly small batches of parts—including burr-free parts—due to increased personalization of medical and dental devices*
- *Managing new materials in addition to conventional turnable materials*
- *Maintaining the highly precise processes necessary to manufacture increasingly complex parts*
- *Mastering technological changes, such as going from Swiss-type to multispindle turning*
- *Consistently delivering the high-quality, complaint parts your customers demand—and on which patients depend*

*Your ability to thrive within these parameters is one of your best means of success.*

## Our experience

*With decades of close partnership with medical/dental suppliers and OEMs worldwide, Tornos provides tools and in-depth application know-how for a wide variety of devices, from bone screws to medical electronics components. Our medtech customers worldwide know that they can rely on us—it's rare to find a medtech OEM without a Tornos solution in its machine fleet.*

*Central to our deep knowledge of Swiss-type and multispindle turning—including milling, thread whirling, drilling and stamping—is our vast knowledge of conventional and emerging materials. We know stainless steels by heart, as well as titanium, PEEK, cobalt chromium and emerging hybrid materials. We push our solutions to their limits in search of the perfect combination of tools, coolants, temperatures and materials, and we are relentless in our pursuit of optimal cycle times, producing the perfect, highly precise burr-free parts. We pride ourselves on our solutions' ability to grip a part from the inside over a thread and after a thread due to two special clamping systems that can be integrated on the counter spindle, and we have mastered what are likely the smallest and longest holes ever created by a Swiss-type lathe.*

*If you are looking for a partner unwilling to back down from even the most formidable challenge, we invite you to experience Tornos. We keep you turning.*



*The more challenges  
you overcome, the  
greater your success.*



Trauma and extremities



Medical and dental tools



Medical and dental tools



Medical and dental tools



Trauma and extremities



Medical and dental tools



Medical and dental tools



Trauma and extremities



Spine

Medical and dental tools



Spine

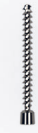

Trauma and extremities



Trauma and extremities



Spine



Trauma and extremities



Medical and dental tools



Medical connectors



Trauma and extremities



Medical and dental tools

Screws used to anchor dental implants present challenges similar to those used in other medical applications, and today's Swiss-type lathe kinematics offer a B-axis system to produce the necessarily complex milled forms.

With Tornos' B axis, the cutting tool angle can be adjusted from 0 to 90 degrees to generate the perfect geometry. This attachment accommodating rotating milling and drilling tools can be used on both the main and subspindles of the machine. Other benefits include one-setup machining, reduced production time and better geometric tolerance; plus, rotating milling cutters deliver high surface finishing in both roughing and finishing passes. Programming each angle of the numerical B axis remains easy, thanks to our specific macro and CAD/CAM assistance. Our programming system can even make it possible for you to complete your parts using just one machine. That's what we call flexibility.

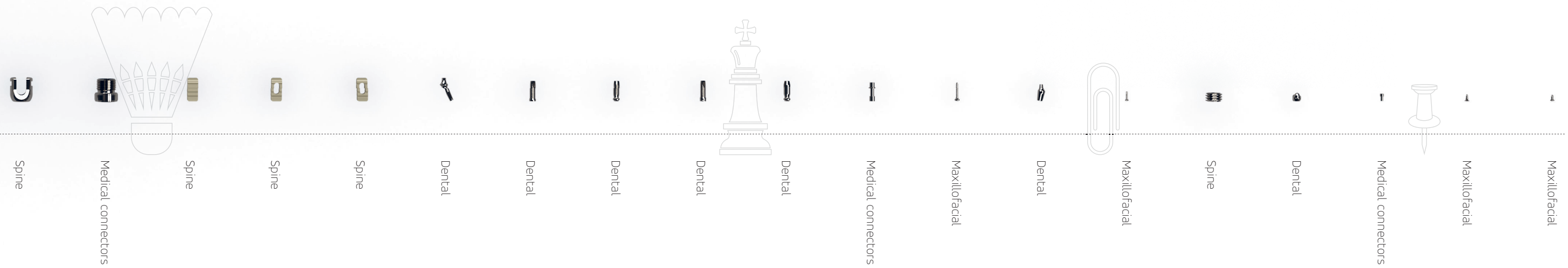



# Flawless results on the most challenging parts

DENTAL IMPLANTS DO FAR MORE THAN ENSURE A NICE SMILE. THEY RESTORE QUALITY OF LIFE AND COMFORT WHILE SLOWING OR STOPPING BONE LOSS. THESE IMPLANTS, INCLUDING BONE SCREWS, ABUTMENTS AND LOCKING SCREWS, MUST BE BIOCOMPATIBLE AND ABLE TO WITHSTAND THE VARIETY OF COMPRESSIVE, TENSILE AND SHEAR FORCES OF BITING AND CHEWING.

TORNOS' MASTERY OF SWISS-TYPE LATHE KINEMATICS ENSURES THE FLAWLESS RESULTS DENTAL IMPLANT MANUFACTURERS EXPECT, EVEN ON CHALLENGING PARTS LIKE DENTAL ABUTMENTS.

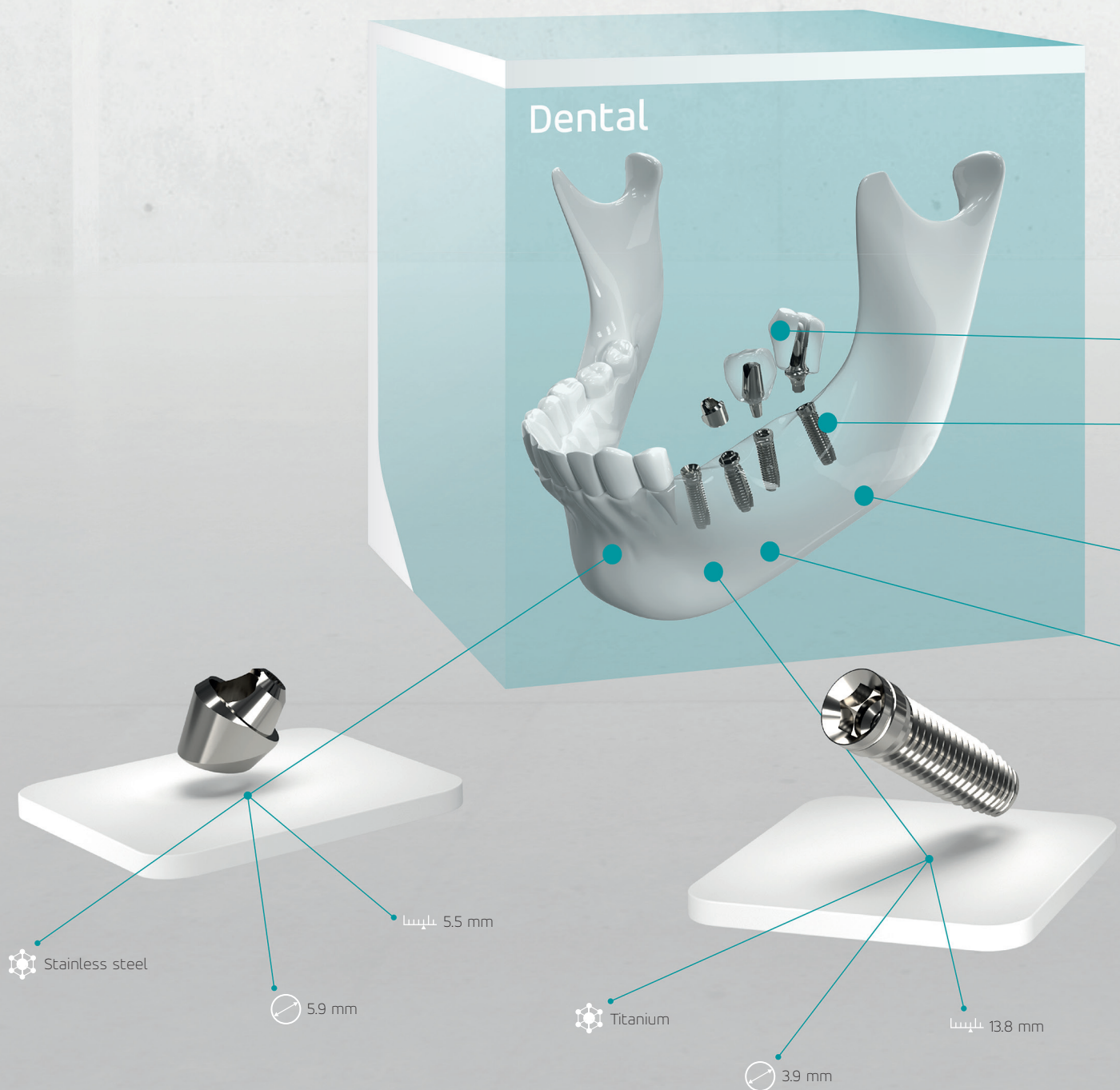

Material

Diameter (in mm)

Length (in mm)

Screws used to anchor dental implants present challenges similar to those used in other medical applications, and today's Swiss-type lathe kinematics offer a B-axis system to produce the necessarily complex milled forms.

With Tornos' B axis, the cutting tool angle can be adjusted from 0 to 90 degrees to generate the perfect geometry. This attachment accommodating rotating milling and drilling tools can be used on both the main and subspindles of the machine.

Other benefits include one-setup machining, reduced production time and better geometric tolerance; plus, rotating milling cutters deliver high surface finishing in both roughing and finishing passes. Programming each angle of the numerical B axis, programming remains easy, thanks to our specific macro and CAD/CAM assistance. Our programming system can even make it possible for you to complete your parts using just one machine. That's what we call flexibility.

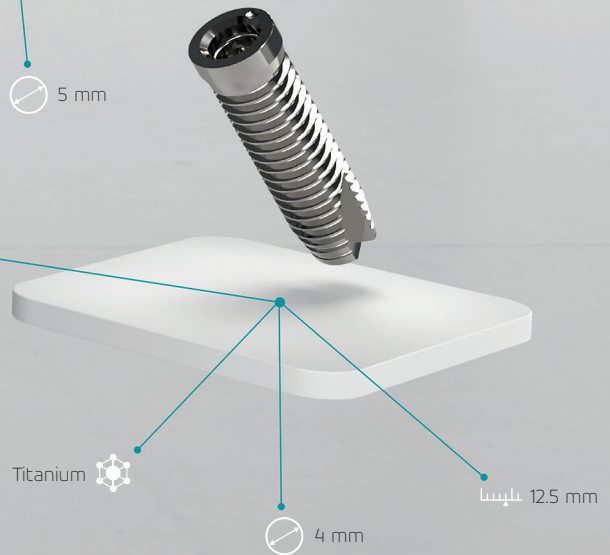
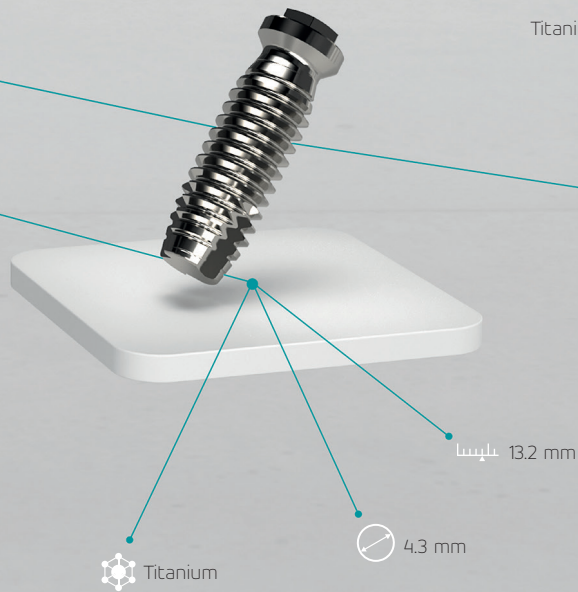
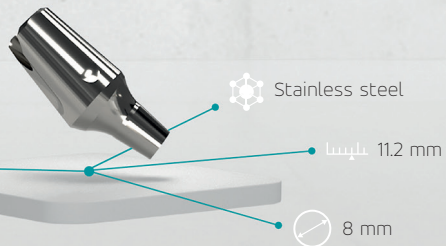

# Machining surgical tools that require tremendous versatility

BEHIND EVERY MEDICAL AND DENTAL PROCEDURE IS AN ARRAY OF TOOLS SPECIALLY DESIGNED TO HELP THE CLINICIAN CUT, CLAMP AND OCCLUDE, RETRACT AND EXPOSE, AND CLAMP AND HOLD AREAS OF THE BODY DURING SURGERY. THESE TOOLS—OFTEN COMPLEXLY SHAPED—ARE LITERALLY THE HAND OF THE CLINICIAN. THEY REQUIRE IMMENSE PRECISION BUT ALSO MUST BE EASILY SANITIZED, ECONOMIC AND, IN SOME CASES, ACCOMMODATE ROBOTIC HANDLING. THAT'S WHY MANUFACTURERS OF MEDICAL AND DENTAL TOOLS TURN TO TORNOS FOR HIGHLY VERSATILE SOLUTIONS.





Material



Diameter (in mm)

الطول Length (in mm)

Machining surgical tools requires tremendous versatility from the machine itself and typically involves a significant amount of milling. That's where a turning machine can deliver the flexibility medical and dental tool manufacturers require. Tornos solutions allow these manufacturers to confidently tackle a wide range of complex tools and deliver the highly precise machining results that can make a difference in clinicians' work and patients' lives.

Sometimes called upon to machine bars more than 30 mm in diameter, Tornos solutions are extremely rigid machines that make easy work of heavy cuts. From surgical and dental instrument to parts for robot-assisted minimally invasive surgery, and whether you need the versatility of turning and milling in one machine, specific development support, or the ability machine prismatic parts by lathe, Tornos is your hands-on expert.



# A perfect connection for medical electronics

WHEN IT COMES TO PATIENTS' HEALTH, ESTABLISHED AND RELIABLE CONNECTORS FOR MEDICAL ELECTRONICS ARE A MUST-HAVE. YOUR MEDICAL CONNECTORS MUST PERFORM WITHOUT ERROR UNDER THE MOST DEMANDING HOSPITAL CONDITIONS. THAT'S WHY MEDICAL ELECTRONICS MANUFACTURERS AND THEIR SUPPLY PARTNERS SO OFTEN RELY ON TORNOS SINGLE-SPINDLE LATHES IN THEIR PRODUCTION OF CONNECTORS. OUR SOLUTIONS ENSURE THE PERFORMANCE THAT YOU EXPECT AND PERFECTION THAT PATIENTS DESERVE.

*Medical electronics, including cardiac assist devices, diagnostic equipment and instruments for surgical and therapeutic application, demand utmost precision and hygiene to maximize usability while minimizing risk. These strict demands apply not only to the devices, but to their connectors, as well.*

*Tornos Swiss-type lathes yield perfect grippers for push/pull connectors and peerless threads that hold the connectors in place. Whether your work-*

*piece is made of brass or uses PEEK or plastic as insulation between various tiny pins, your experts at Tornos ensure your successful production of connectors of medical electronics. Our expertise makes it possible for you to manufacture lightweight, durable, compliant, and watertight connectors in a highly productive, cost-effective manner.*

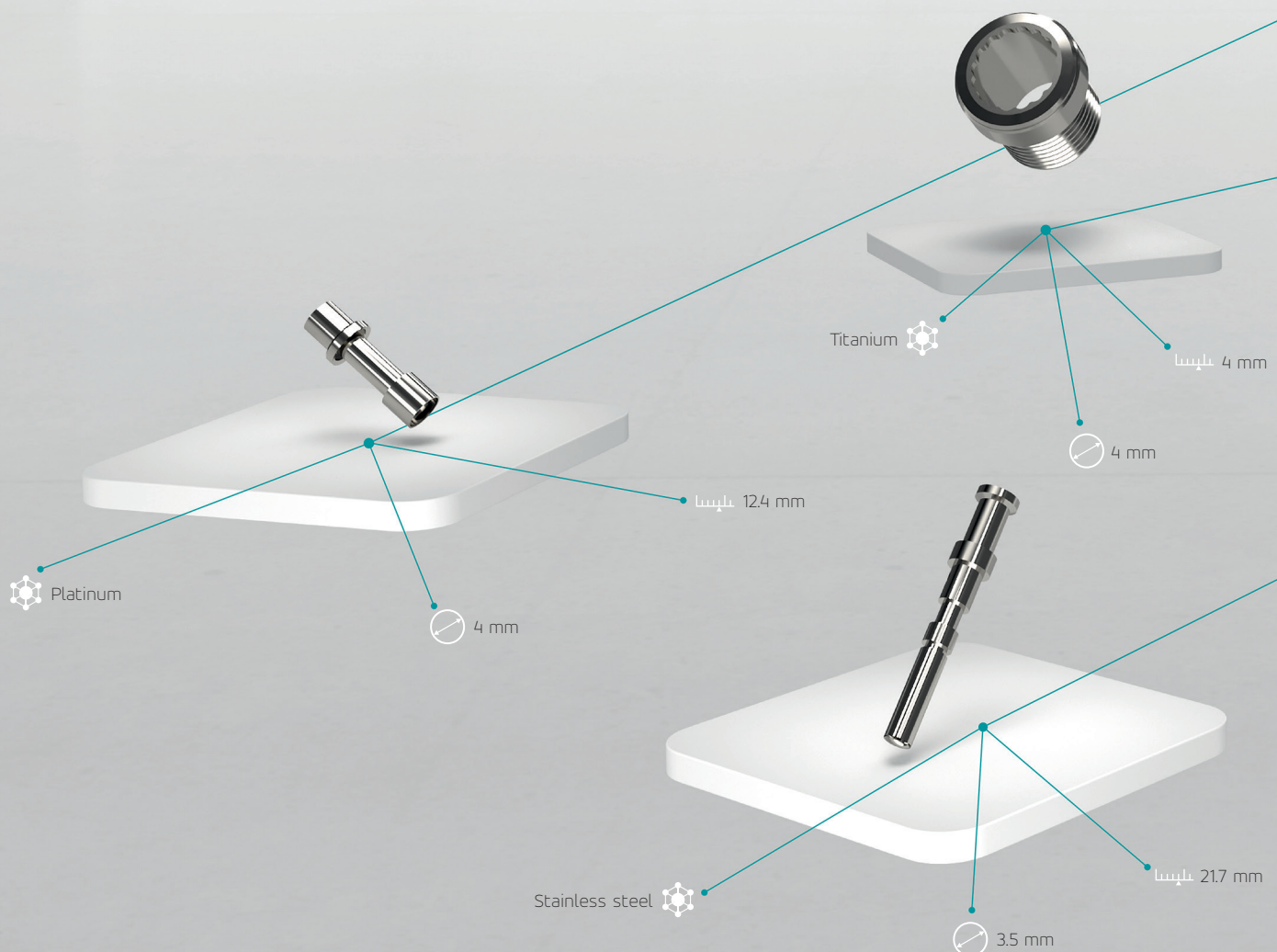



Material

Diameter (in mm)

الطول Length (in mm)

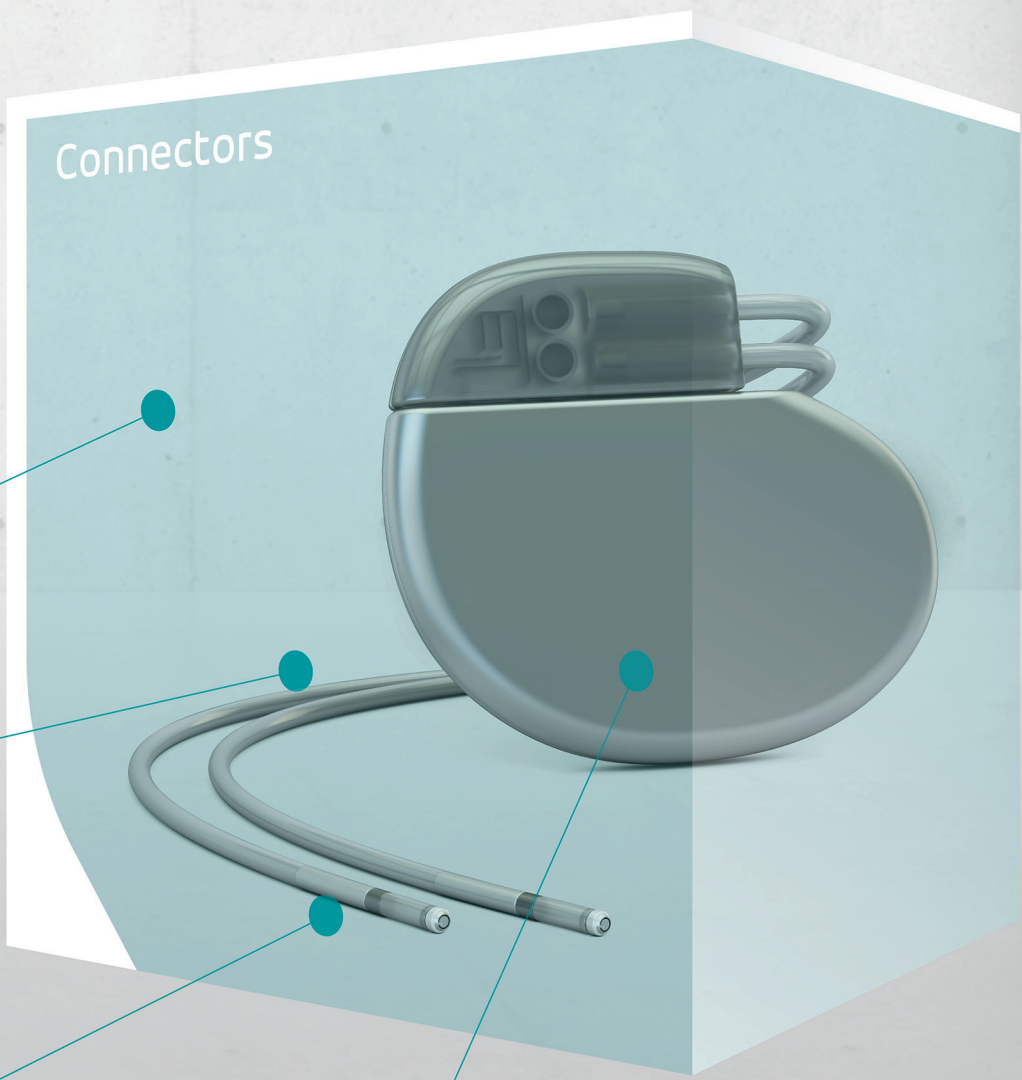

# Connectors

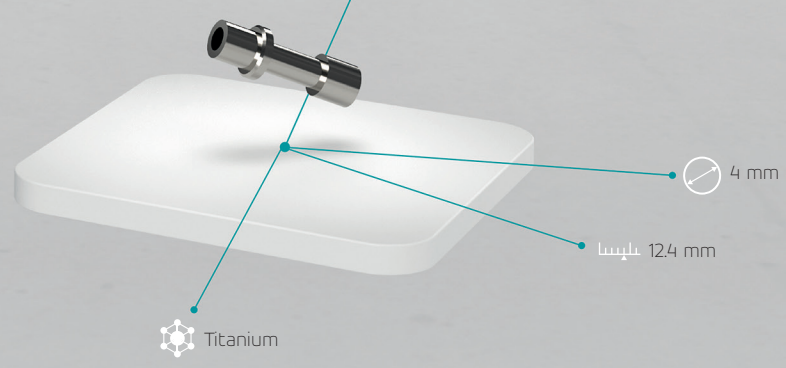

Titanium

4 mm

الطول 124 mm

# With a solution for every challenge, we secure our customers' application success, operational uptime, quality, and efficiency.

## **Meet the future of automation with Tornos' Custom Development Department**

*With a team of engineers dedicated to customizing our solutions to meet your specific needs, Tornos' Custom Development Department is at the heart of innovation. Our latest innovation—an automation cell featuring a collaborative robot—is evidence of our innovation focus. It is designed to optimize and flexibilize the use of our MultiSwiss 8x26 machines.*

## **An integrated, versatile robotic system**

*Our new robotic solution stands out for its ability to adapt to a variety of tasks and production environments. The robot, mounted on a cart or directly on the machine, can be easily moved and configured to serve several machines. After machining, the robot takes charge of the parts, performing post-processing operations such as cleaning, measurement and alignment, with no need for human intervention.*

## **Automated measurement and correction**

*Innovation doesn't stop at task automation. Our system also includes advanced automatic measurement and correction functions. Thanks to a specific measuring system, the robot can measure parts (according to various statistical control criteria) and report back to the machine to automatically adjust various parameters. This feature ensures consistent quality and reduces the need for manual checks.*

## **Availability and adaptability**

*This option is available immediately and can be integrated into existing products, offering immediate added value to your current production process. Our team is ready to adapt this solution to the specifics of your working environment, ensuring smooth and efficient integration. Discover how our customized, innovative solutions can meet both your current and future needs.*

## **Solution: machining of PEEK parts**

*Specialized solutions are essential to the ever-evolving medical and dental sectors. As a long-time collaborating partner of medical device manufacturers, Tornos has the solutions to precisely meet your demands—and machining of PEEK parts is among them.*

*Tornos demonstrates its expertise with PEEK parts intended for medical applications. A special clamping solution allows part gripping in counter-operation; the clamping operation can be carried out on both rounded or straight machined shapes. PEEK parts to be implanted cannot be exposed to coolant during the machining process, so these parts require dry machining. Chips and process-induced heat are managed by guided, cool air flows. The machine itself must be adapted and prepared to machine only PEEK. For example, all lubricants must be compatible with PEEK material.*

*Your direct benefits of turning to Tornos for PEEK machining solutions include the ability to use rotating tools to perform various operations (drilling, milling, deburring or engraving, for example) on either side of your workpiece. This is made possible by the counter-spindle clamp allowing non-enveloping lateral clamping. Air cooling is fully compatible with PEEK's constraints, so you never have to worry about your workpiece being contaminated by coolant. The benefits of our air cooling are twofold: It prevents PEEK from overheating, therefore preserving the material's microstructure and chemical composition, and it removes the chips. Our EvoDECO automatic lathes are entirely suitable for machining perfectly precise disc/cage implants, depending on their size and complexity.*

*Tornos also has a solution for your applications requiring drilling and milling operations with rotating tools tiltable by guide bush. Our rotating spindle device with inclination adjustment is available for the EvoDECO 20 and EvoDECO 32. Installed on the rear platin, this solution has a standard drive system for rotating tools.*

When you need to perform angular machining, the spindle can be inclined from 0 to 90 degrees in one-degree increments. Our Swiss GT series and our EvoDECO 16 feature a B axis to even further extend into machining capabilities.

For high precision applications, look to our SwissNano Swiss-type lathe, with its six computer-numerical control axes, thermal stability and high rigidity. The kinematic structure was designed for exemplary balance and thermal management enables the operating temperature to be achieved very rapidly.

### **Solution: machining complex shapes**

Certain components, especially spinal implants, orthopedic bone screws and nails, and dental implants, require especially specific solutions—generally milling—for machining complex shapes. Tornos pioneered this technology in turning with the EvoDECO 16 and, today with TISIS CAM, paves the way to true mastery when it comes to programming for highly complex parts.

With our deep five-axis machining expertise, we have developed solutions—such as our Swiss GT 26B and Swiss GT 32B, our SwissNano, and our new SwissDECO—, that give you full numerical control of your axes so you have the confidence to tackle extremely complex medical and dental components in a single setup. Programming is easy, thanks to specific macros for automatic calculation of axis offsets and incremental program steps. In parallel, you experience very short control and start-up times.

If you're looking to gain a competitive edge in the highly competitive medical device manufacturing market, look no further than our Swiss GT 26B and Swiss GT 32B. With the kinematics of their powerful and versatile six linear axes, your operator can work symmetrically in both main and counter operations with three numerical axes. With an innovative design guaranteeing good rigidity and powerful spindles, our Swiss GT 26B and Swiss GT 32B take the Swiss-type lathe into a new era.

Tornos' SwissNano is the champion for manufacturing small—even micro—medical and dental parts requiring very high precision. The machine's unique kinematics enable turning, drilling, cutting, deburring, roughing and finishing operations for the tiniest parts, whether simple or extremely complex. Behind the SwissNano is a machine concept delivering exemplary balance and thermal management allowing perfect results. This compact solution offers excellent accessibility for easy setup and can be used with a fixed/rotating guide bush—or no guide bush at all.

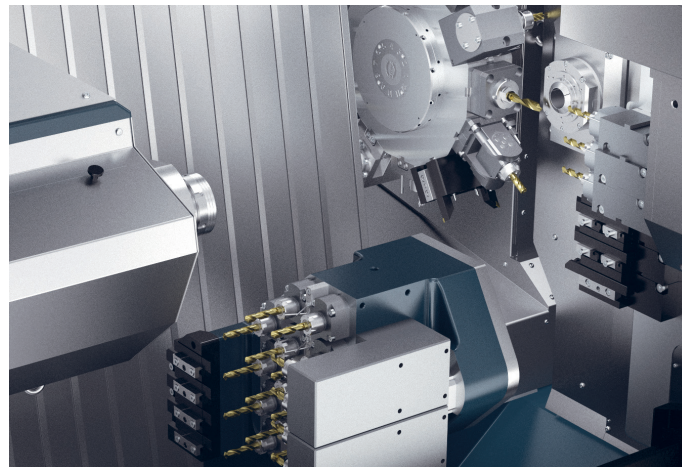

At the same time, the new multitasking SwissDECO platform represents Tornos' vision of the future of the Swiss-type lathe. Its enhanced machining and tooling solutions make it superb for medtech applications. The compact SwissDECO, available in four versions, enables highly productive, extremely precise and high-quality production of complex parts, thanks to its optimized programming tools and ideal ergonomics to speed up parts programming and shorten machine preparation and setup. All of the SwissDECO solutions are built on a common, sturdy 36 mm base and are designed and optimized with finite element method (FEM) analysis.

### **Solution: faultless quality**

To ensure the level of quality required for the production of medical and dental devices, Tornos partners with specialists in controlling and measuring procedures and has developed an interface that is able to communicate with various types of measuring systems. Data from this interface is made available to suppliers of these systems who then adapt them. This partnership guarantees total compatibility between the machine and the measuring system for the operator who, as a result, has one less major issue.

This interface is available on single- as well as multispindle machines and allows corrective data to be transmitted. If the measuring system detects a gradual drift from input data—due to tool wear, for example—a corrective measure is automatically triggered by the turning machine's control unit. In this way, the operator can monitor both tool wear parameters and any sudden shift from an input dimension resulting from tool failure, because in this case the system automatically actuates an alarm and can stop the machine.

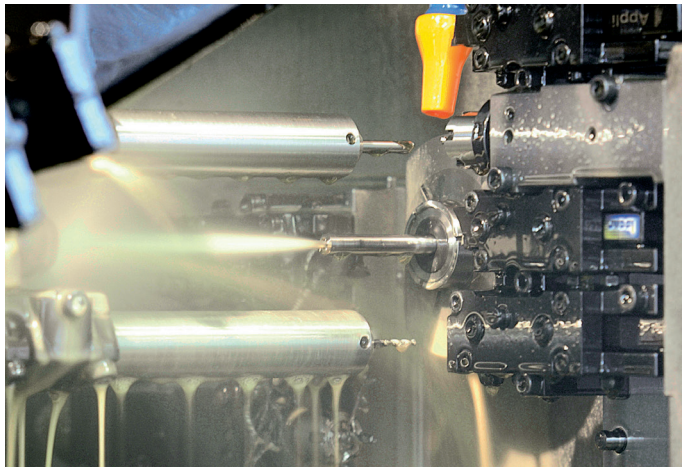

### **Solution: thread whirling**

When it comes to machining screws for medical and dental applications, Tornos' unique thread whirling expertise—acquired as a go-to partner to medtech manufacturers—is a strong asset. We are the only company offering this process on multispindle and single-spindle lathes.

With nearly 30 years of thread whirling mastery, Tornos solutions enable production of biocompatible screws with flawlessly sharp threads, required surface finish and highest geometric accuracy. Increase your productivity and say goodbye to bending and vibration with our legendary thread whirling process.

### **Solution: high-pressure coolant**

Increasing the coolant pressure has a positive effect on both chip breaking and tool life. Tornos' high-end machines designed for high productivity have a tool holder with fixed nozzles to enable high precision of the coolant supply at the cutting edge of the insert, a direct route to excellent chip breaking, process security and high productivity.

Coolant delivery optimizes the machine capabilities and further improves tool life and chip formation. Since the early 2000s, machine builders have increased the pressure and flow on their machines each year, resulting in increased electrical power consumption. With our latest products, Tornos has defeated this dilemma with built-in coolant that increases precision in the oil jet to reduce the flow and, consequently, reduces energy consumption of the machine while achieving the same highly precise results.

The coolant jet has four main effects:

- Cooling the insert in the contact zone
- Quickly forcing the chip away from the insert face, reducing wear on the insert
- Helping to break the chip into smaller pieces and evacuate it from the cutting area
- For rough turning, a coolant pressure of 80 bars provides longer tool life than regular pressure

#### **Tool life—times seven**

By applying a coolant pressure of 80 bars, tool life increases by seven times in the finishing operation. The wear value (VB) is lower after 33 minutes in a cut with 80-bar pressure, than after less than five minutes with a conventional coolant pressure of 15 bar. For the roughing operations, tool life is increased by approximately 40 percent when using high-pressure coolant.

### **Solution: additional handling**

Medical and dental parts machined on an automatic turning machine are often extracted by freefall. Trends are toward monitored parts and palletization of parts. Here, parts are gripped by a collet that transfers them to a pallet system. For continuous production, the capacity of such a system merely depends on the type of installation. One variant is the use of a robot to load stamped workpieces and unload machined parts. This kind of automated model does not complicate things for the operator; even the programming can be carried out in standard mode.

Advantages of automatic loading:

- Reduced cost due to less part handling
- Less part damage due to controlled part unloading
- Lower throughput time from production to delivery
- Consistent quality, uncompromised by human factors

### **Solution: chucker**

The requirements in terms of chuckers are continuously evolving. Both profiles and dimensions are changing. To ensure maximum flexibility, a robot fitted in place of the slide in position 1 now offers easier loading for different types of parts, allowing angular positioning of the parts. An additional advantage of using a robot is the ability to unload parts in a controlled way, as far as the machining time will allow. The “robotic loading” chucker concept can be adapted for use with the entire range of machines.

### **Solution: chip management**

Depending on the volume and the material to be machined, swarf extraction is a process that can cause the most problems, especially if the operator requires automated production that includes minimum monitoring.

To overcome this, we advise removing swarf using high-pressure pumps (35 or 80 bars). Additional assistance is available for the operator in the form of a universal swarf conveyor that handles several types of swarf from brass and aluminum to stainless steel.

An important factor in chip management is the way the oil is filtered. Clean oil is necessary to use a high-pressure pump and increase tool life and machining quality. In addition, the life of the pump's chiller and other peripherals in the loop is increased. We constantly filter our oil; when a filter is dirty, we automatically clean it without interrupting the machining process. On our single-spindle solutions, we offer a fluid manager aggregate that concentrates filtering, high-pressure pumps and thermal stabilization in one single unit specifically developed and fine-tuned to serve you. On the peripherals and equipment side, Tornos builds partnerships on the basis of its extensive experience.

### **Solution: painless programming**

Every work position on our multispindle turning solutions is equipped with its own spindle. Has your programming started to become highly complex? A turning machine equipped with more machining options logically requires programming to match the machine's capacities. As each of the multispindle work stations is equipped with its own drive system, its programming is done by station. This facilitates the programming of the turning machine, which becomes as straightforward to program as a three-axis single-spindle machine.

It's natural to assume that programming machines of more than 30 axes must be complicated. However, thanks to the TISIS programming software and Tornos' multispindle kinematics, you only need to program three axes six or eight times—extremely straightforward. The fact that each work station is equipped with its own powered spindle means optimum machining processes can be carried out at this station without worrying about the others. Managing the turning machine is therefore simplified. Operators enjoy increased flexibility in the programming of their parts. Thanks to independent speeds, they can select a wider range

of tools as well as the perfect speed. The operator's expertise is very useful and in workshops equipped with both single- and multispindle turning machines, operators will always be within the same programming family.

### **Programming intelligence**

In today's competitive global marketplace, there's not a moment to waste in meeting customers' demands.

Our available TISIS communication and programming software puts you on the fast track to truly effortless programming and real-time process monitoring. TISIS knows your Tornos machine fleet and can help you decide which machine to use for a specific part—but that's not all. It enables you to assess each machine's options, reduces the risk of collisions and resulting stoppages, and improves your productivity and efficiency.

TISIS is a smart and advanced ISO code editor that does the thinking for you. It knows your Tornos machine inventory, can help you write your code, and points out any coding errors. It puts the code in color and can display your program in an attractive, readable Gantt diagram, making it easy for you to see the critical path and react quickly to optimize the process.

At the same time, TISIS is Industry 4.0 ready and takes the complexity out of process monitoring. Even from a remote location, you can keep an eye on the details of the machining process from your smartphone or tablet. The software also allows you to quickly transfer your programs by USB key or directly onto the machine. Your parts designs in various stages of completion can be stored with your program and your parts are easily retrieved from the database.



# Tornos Service

*Backed by both geographical proximity to customers and a keen understanding of their processes, applications and market challenges, Tornos Service delivers an unparalleled continuum of support: start-up assistance; expert training and coaching; free hotline; on-site operations support and preventive maintenance; original spare parts seamlessly delivered worldwide; complete overhauls to extend the longevity of Tornos machines; and a range of operations and upgrades to expand your application capabilities and profitability.*

*Buying a Tornos machine is much more than a business transaction. It is your investment in the future. Tornos Service thrives worldwide on securing the predictably high production capability of products carrying the Tornos name.*

*Situated close to you, as demonstrated by the 14 Tornos Service Centers strategically located across Europe, Asia, and the Americas, Tornos Service offers a full continuum of authoritative support for you and your Tornos machines, and encompasses the innovation, reliability and attention to detail expected of a premier Swiss brand. And it is all backed by a 100-year legacy of expertise and in-depth understanding of customers' processes, applications and challenges across a wide range of industrial segments, including automotive, medical and dental, electronics and connections, and micromechanics.*

## **Start-up assistance**

*From the first feasibility tests prior to purchase, you are in good hands with Tornos Service. In our state-of-the-art Techno Centers, expert application engineers support you with tests to gauge the feasibility of machining processes and applications. With start-up assistance, you are secure in the knowledge that you will never be left alone to deal with a brand new machine.*

## **Expert training and coaching**

*Engineered for intuitive and easy use, Tornos machines offer a vast range of options and enable myriad processes. Expert training and coaching help your employees become programming, handling and maintenance experts, adding more value to your processes, applications and products.*

## **Free Hotline support**

*Wherever you are in the world, highly qualified specialists who speak your language and understand your processes are just a phone call away to quickly support you with handling and programming solutions.*



Discover  
Tornos Service

### On-site support

Fast, efficient on-site operations and preventive maintenance ensure the continuous high performance of your Tornos machines. Regular scheduled preventive maintenance can help you avoid 70 percent of machine breakdowns and keep you on the path to productivity.

### Certified original spare parts

Rapid, reliable, worldwide delivery of certified original Tornos spare parts is a specialty of Tornos Service. Regardless of the age of your Tornos machine, we stock the essential certified spare parts to keep the machine running at peak performance.

### Machine overhauls

Tornos machines inspire confidence, so it's no surprise that many customers turn to Tornos for complete overhaul of their workhorse machines. Tornos' overhaul service returns the machines in good-as-new condition, appreciably extending their longevity.

### Options and upgrades

To help you achieve your manufacturing, productivity and quality objectives, our experts collaborate with you to manage complex machining processes, develop software features for machining complex shapes, design special equipment, and tailor peripherals to customers' needs.

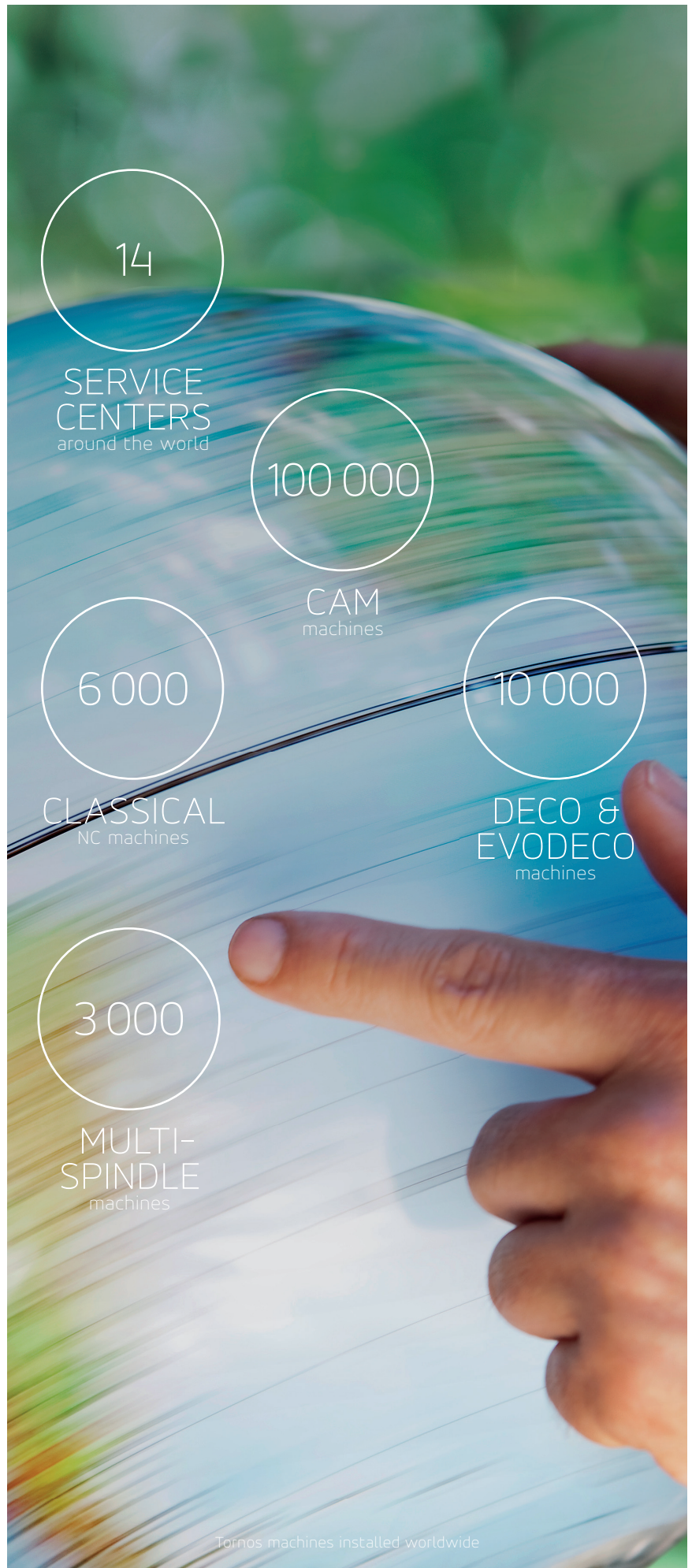

Tornos machines installed worldwide

Truly best value goes beyond calculations like ROI and total cost of investment to deliver optimal life cycle cost.

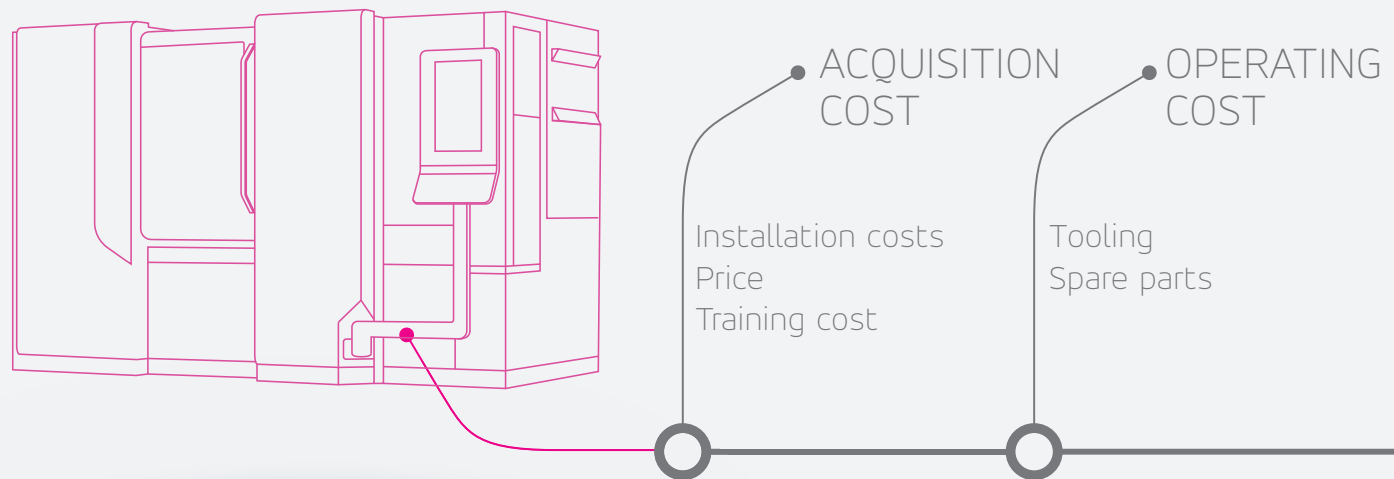

In the face of myriad medical industry opportunities and challenges, *Tornos keeps suppliers turning with solutions that ensure appreciable return on investment (ROI)*. Manufacturers often focus only on equipment price when calculating ROI, not taking into account the total life cycle cost or anticipated performance of the equipment. The price-only philosophy can make you forget the reality that acquisition, operating, maintenance and decommissioning costs can all affect a machine's true cost.

Tornos solutions continue to serve you well beyond the classical five-year amortization period. Our machines are designed to withstand years of heavy-duty production.

A low-cost machine is fully depreciated after three or four years, so it looks inexpensive on the accounting books. This type of thinking leads many manufacturers to keep the machine running in the shop long after it should be retired. A lower-cost machine leads to high maintenance costs, insufficient part quality and increased waste of material and parts. After three years, such a machine has minimal value. In contrast, *a high-performance Tornos machine can extend component life and reliability, reduce maintenance costs and retain 50 percent of its value on the used market at the end of three years*. These benefits should be factored into actual ROI.



IT'S NO WONDER RENOWNED MEDICAL MANUFACTURERS AND THEIR SUPPLY PARTNERS CHOOSE OUR TECHNOLOGIES, PRODUCTS, EXPERTISE AND SERVICES.

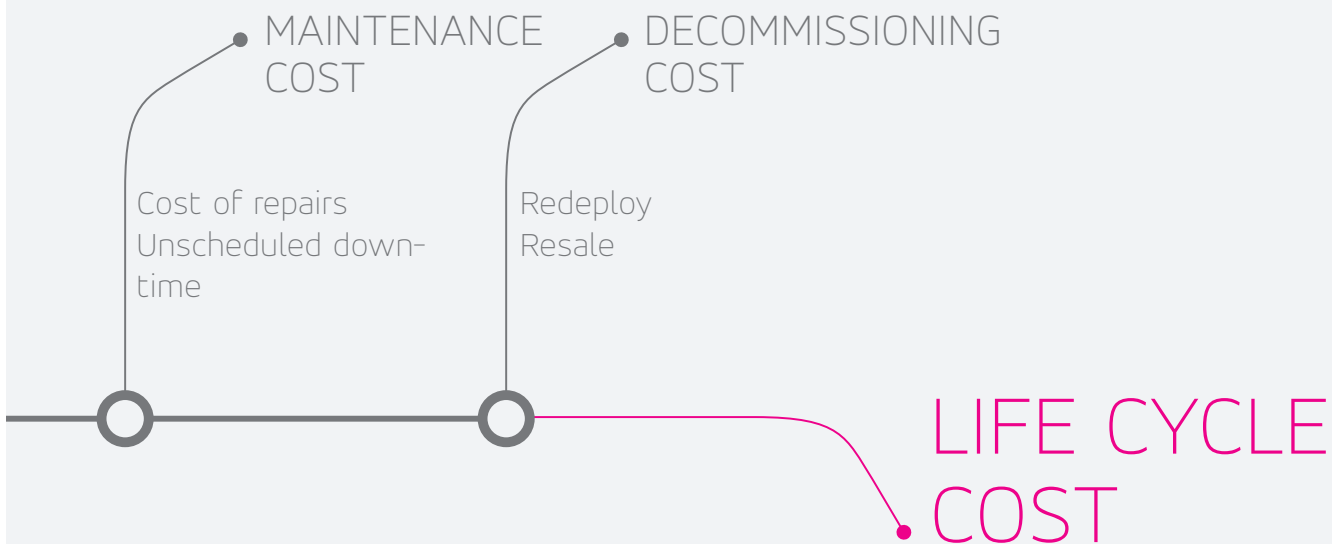

*Price is only one facet of a machine's cost, as the life cycle cost model illustrates well:*

*Costs considered*

- Price
- Cycle time

**Costs usually ignored:**

- Product performance
- Product life cycle
- Financing costs/cash flow
- Tooling
- Unplanned downtime
- Repair costs
- Labor
- Waste
- Redeployment costs
- Administrative costs
- Installation
- Utilities (software, etc.)

tornos.com

TORNOS LTD

Rue Industrielle 111  
CH-2740 Moutier  
Phone +41 (0)32 494 44 44  
Fax +41 (0)32 494 49 03  
contact@tornos.com

Tornos  
throughout  
the world

